









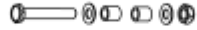

Standard table

N0	Schematic Diagram	Quantity	N0	Schematic Diagram	Quantity
1	M10 x 80 bolt, washer, nut 	4	2	M10 x 75 bolt, washer, nut 	2
3	M10 x 20 bolt, washer 	2	4	M10 x 65 bolt, washer, nut 	2
5	M10 x 45 bolt, washer, nut 	4	6		2
7	60 foot cover 	2	8	pulley 	6
9	∅25-∅50 buffer washer 	2	10	∅48-∅70 buffer washer 	2
11	gourd buckle 	5	12	∅3.0x60 elastic cotter pin 	2



cabla (3,090mm)  X 2

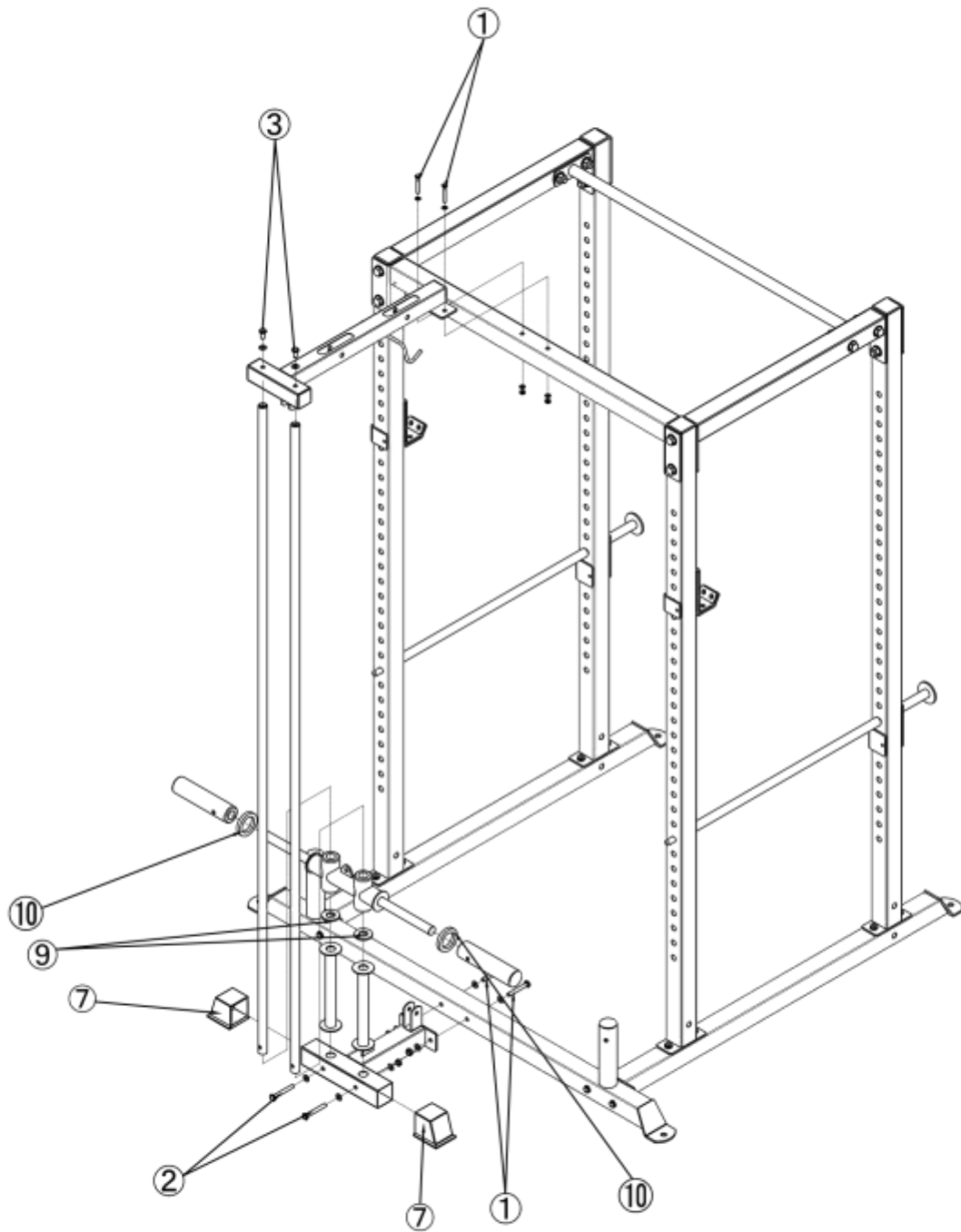